

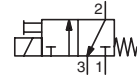

SOLENOID VALVES

ISO 15218 (CNOMO, size 30) interface
direct operated, pad mounting body
subbases for instant fittings or 1/8 thread

NC



3/2
Series
190

FEATURES

- CNOMO pad-mount version for valve piloting applications
- Compact size and low weight for easy installation on single or joinable subbases
- AC/DC interchangeability of the solenoid operator without any need for disassembly of the valve
- Version with M12 connection with visual indication and peak voltage suppression conforming to "UL" standards
- Flexible installation on joinable subbases
- Manual operator as standard
- The solenoid valves satisfy all relevant EU directives

GENERAL

Differential pressure See "SPECIFICATIONS" [1 bar = 100 kPa]
Maximum allowable pressure 16 bar
Response time 5 ms

fluids (*)	temperature range (TS)	seal materials (*)
air, inert gas	- 10°C to + 60°C	NBR (nitrile)

MATERIALS IN CONTACT WITH FLUID

(*) Ensure that the compatibility of the fluids in contact with the materials is verified

Body PA, glass-filled
Core tube Stainless steel
Core and plugnut Stainless steel
Internal parts, springs Stainless steel
Seals NBR
Shading coil Copper

CONSTRUCTION

Mounting pad ISO 15218 (CNOMO 06-05-80 / NF E 49066, size 30)

ELECTRICAL CHARACTERISTICS

Coil insulation class F
Connector Spade plug (cable Ø 6-10 mm) or M12
Connector specification ISO 4400 / EN 175301-803, form A or CNOMO E03.62.520.N (M12)

Electrical safety IEC 335
Electrical enclosure protection Moulded IP65 (EN 60529)
Standard voltages DC (=): 24V - 48V (M12: 24V + LED and protection)
AC (~): 24V - 48V - 115V - 230V / 50 Hz
(Other voltages and 60 Hz on request)

-	power ratings				operator ambient temperature range (TS) (C°)	replacement coil		type ⁽¹⁾
	inrush	holding	hot/cold	~		=		
	~	~	=					
(VA)	(VA)	(W)	(W)	230 V/50 Hz	24 V DC			
-	9	4	3	3 / 3	-10 to + 60	43004472	43004473	01
-	-	-	-	-	-	-	43005525	06

⁽¹⁾ Refer to the dimensional drawings on the following page.

SPECIFICATIONS

pipe size	orifice size		flow at 6 bar		flow coefficient		operating pressure differential (bar)			power coil (W)		catalogue number							
	1 → 2		2 → 3		1 → 2		2 → 3		min.	max. (PS)		without man. operator	maintained man. operator	impulse man. operator	button man. operator	with connector	without connector	M12 connection	
	(mm)	(mm)	(l/min)	(ANR)	(l/min)	(l/min)	~	=		~	=								~/=
NC - Normally closed																			
pad mounting ⁽²⁾	1,6	1,5	70	84	1	1,2	0	10	10	3	3	×	●	▼	■	19000005	19000013	19000043	
																19000006	19000014	19000044	
																19000017	19000018	19000046	
																19000008	19000016	19000045	

SUBBASES

pipe size	designation	composition	catalogue number
6/6 polyamide subbases			
instant fittings ⁽³⁾	single subbase (instant fittings OD 4 mm)		35300069
	joinable subbase (instant fittings OD 4 mm)		35300070
	set of 2 joinable end subbases, right-hand pressure intake, endpieces with instant fittings OD 6 mm		35300071
	set of 2 joinable end subbases, right-hand and/or left-hand pressure intake, endpieces with instant fittings OD 6 mm		35300072 ⁽⁴⁾
Zamak subbases			
G 1/8 ⁽³⁾ tapped	laterally-connected single subbase		35300047
	laterally-connected joinable subbase		35300048

⁽²⁾ Port 3: M5.

⁽³⁾ These subbases can be mounted on omega rail to EN 50022 using 2 clips (clips sold in packs of 10, catalogue number: 33400036).

⁽⁴⁾ The equipment can be used for two different pressure intakes, supplied with one blanking plug to cover unused port.

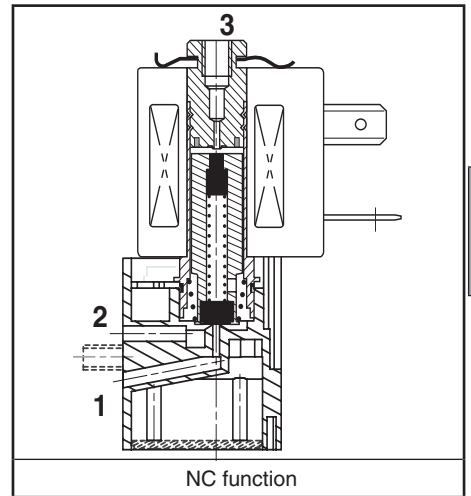

E

OPTIONS

- Explosionproof enclosures for use in zones 1/21-2/22, categories 2-3 to ATEX Directive 2014/34/EU (see "Explosionproof solenoids" section): Ex mb (PV), PV19000005/6/17/8 / Potentially explosive atmospheres (SG), zone 22
- Straight M12 connector (IP67 protection with connector correctly installed): with 5 m cable: catalogue number **88130212**
- Right-angle M12 connector (IP67 protection with connector correctly installed), with 5 m cable: catalogue number **88130213**
- Catalogue number (without connector) + connector catalogue number (with integrated LED indicator and electrical protection): 24 V (~/-), **88122603** - 48 V (~/-), **88122604** - 115 V (~), **88122605** - 230 V (~), **88122608**
- M5 flow control regulator to fit port 3, catalogue number: **34600380**
- Plug with visual indication and peak voltage suppression or with cable length of 2 m (see Solenoids, Coils & Accessories section)

INSTALLATION

- The solenoid valves can be mounted in any position without affecting operation
- Mounting on single or joinable subbases
- ATEX 2014/34/EU versions (options "SG" and "PV") can be installed on single (all versions) or joinable zinc diecast subbases
- Pipe connections 1/8 have standard thread according to ISO 228/1
- Installation/maintenance instructions are included with each valve

DIMENSIONS (mm), WEIGHT (kg)

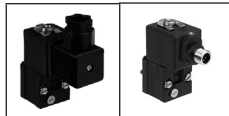

TYPE 01-06
Spade plug /M12
IEC 335 /
EN 175301-803 (11 mm)
E03.62.520.N, IP65

19000005 to 19000045

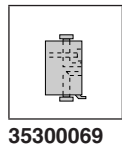
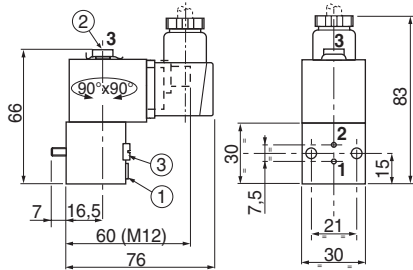

TYPE 02
Single instant fitting
subbase
Polyamide

35300069

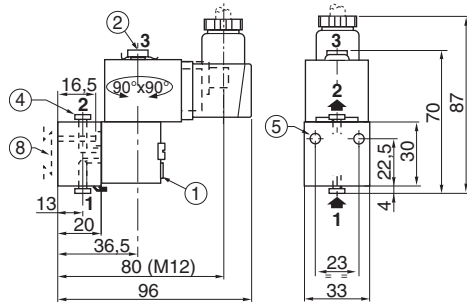

ORDERING EXAMPLES:

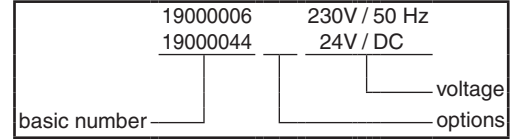

- 1 Manual operator location
- 2 Port 3: M5, depth 5,5 mm
- 3 Mounting: two CM4 x 33,5 screws
- 4 Instant-fitting connection for OD 4 mm tube
- 5 Mounting: two dia. 3,5 mm securing holes, dia. 6,5 mm counter-bores, depth 3,5 mm
- 6 Instant-fitting connection for OD 6 mm tube
- 7 Mounting: two dia. 4,5 mm securing holes
- 8 Adaptable clips
- 9 Subbase mounting hole, adapter

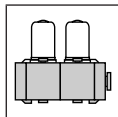

TYPE 03
Joinable instant fitting subbase
Polyamide
35300070
35300071 (set of 2)

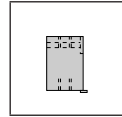
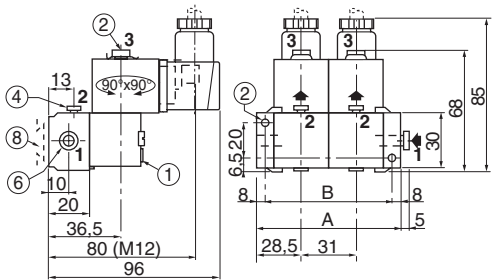

TYPE 04
Single subbase
Zamak
35300047

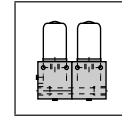
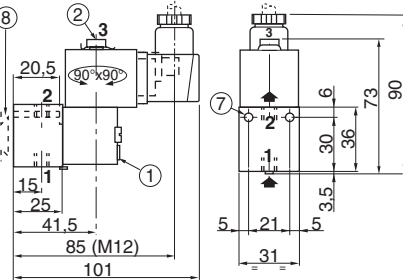

TYPE 05
Joinable subbase
Zamak
35300048

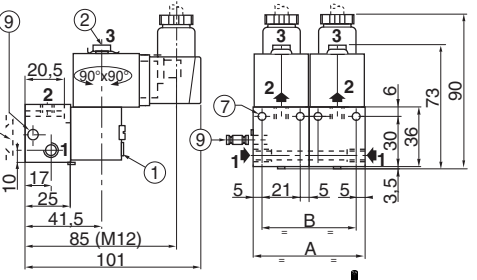

Joinable subbases assembled with adapter locked by sunk set screws. For DIN rail mounting: see type 03.

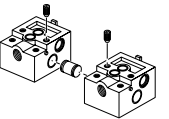

Right-hand pressure intake option or 2 different pressure intakes by procuring the set of two end subbases with endpieces (catalogue number: 35300072). When mounted on DIN rail, it is recommended to use a securing clip on the end subbases as well as on the central subbase.

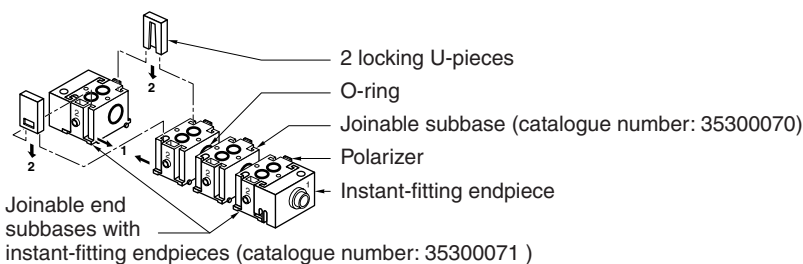

type	weight ⁽¹⁾
01	0,180
02	0,135
04	0,185
06	0,170

⁽¹⁾ including coil and connector.
(except M12 connection type 06)

number of subbases	type 03		type 05	
	A	B	A	B
2	88	72	62	52
3	119	103	93	83
4	150	134	124	114
5	181	165	155	145
6	212	196	186	176
7	243	227	217	207
8	274	258	248	238

type	weight ⁽²⁾							
	number of subbases							
	2	3	4	5	6	7	8	
03+01	0,415	0,610	0,805	1,000	1,195	1,390	1,585	
03+06	0,395	0,580	0,765	0,950	1,135	1,320	1,505	
05+01	0,490	0,735	0,980	1,225	1,470	1,715	1,960	
05+06	0,470	0,705	0,940	1,175	1,410	1,645	1,880	

⁽²⁾ Including seals, set screws and joining unit.